



# RTU-485

## *Modbus Remote I/O Communication Module* Operation Manual



<http://www.delta.com.tw/industrialautomation>



## **Warning**

- ✓ Please read this instruction carefully before use and follow this instruction to operate the device in order to prevent damages on the device or injuries to staff.
- ✓ Switch off the power before wiring.
- ✓ RTU-485 is an OPEN TYPE device and therefore should be installed in an enclosure free of airborne dust, humidity, electric shock and vibration. The enclosure should prevent non-maintenance staff from operating the device (e.g. key or specific tools are required for operating the enclosure) in case danger and damage on the device may occur.
- ✓ RTU-485 is to be used for controlling the operating machine and equipment. In order not to damage it, only qualified professional staff familiar with the structure and operation of RTU-485 can install, operate, wire and maintain it.
- ✓ DO NOT connect input AC power supply to any of the I/O terminals; otherwise serious damage may occur. Check all the wirings again before switching on the power and DO NOT touch any terminal when the power is switched on. Make sure the ground terminal ⊕ is correctly grounded in order to prevent electromagnetic interference.

## **Table of Contents**

<b>1</b>	<b>INTRODUCTION.....</b>	<b>3</b>
1.1	Features .....	3
1.2	Specifications .....	3
<b>2</b>	<b>PRODUCT PROFILE &amp; OUTLINE .....</b>	<b>4</b>
2.1	Dimension .....	4
2.2	Product Profiles .....	4
2.3	RUN/STOP Switch .....	4
2.4	Address Switch.....	5
2.5	Communication Mode Switch .....	5
<b>3</b>	<b>BASIC OPERATION .....</b>	<b>6</b>
3.1	Connecting RTU-485 to DVP Slim DI/DO Extension Unit .....	6
3.2	Installing RTU-485 and DVP Slim DI/DO on DIN Rail .....	6
<b>4</b>	<b>AREAS FOR SPECIAL FUNCTIONS .....</b>	<b>6</b>
4.1	Areas in Digital I/O Module .....	6
4.2	Areas in Special I/O Module .....	7
4.3	Special Functions .....	7
4.4	Error Codes .....	8
<b>5</b>	<b>FUNCTION CODES RTU-485 SUPPORTS .....</b>	<b>8</b>
<b>6</b>	<b>APPLICATION OF RTU-485.....</b>	<b>9</b>
6.1	Connection between RTU-485 and Master Device .....	9
6.2	Application Example .....	9

<b>7</b>	<b>LED INDICATOR &amp; TROUBLE-SHOOTING .....</b>	<b>11</b>
7.1	POWER LED .....	11
7.2	RUN LED.....	11
7.3	ALARM LED .....	11
7.4	RS-485 LED .....	12

## 1 Introduction

1. To ensure correct installation and operation of RTU-485, please read this chapter carefully before using your RTU-485
2. RTU-485 is a Modbus remote I/O communication module for Delta's PLC to remote-control DVP Slim series I/O modules.
3. RTU-485 is a standard Modbus slave device and is compatible with other master devices which comply with Modbus protocol.

### 1.1 Features

- Auto-detecting I/O modules
- Maximum extension: 8 special I/O modules; 128 input points and 128 output points for digital I/O modules

### 1.2 Specifications

#### ■ DeviceNet connection

Transmission method	RS-485
Electrical isolation	500 VDC
Interface	Removable connector (3Pin)
Transmission cable	2-wire twisted shielded cable w/8

#### ■ Communication

Mode	ASCII	7, E, 1	7, O, 2	8, O, 1	
		7, O, 1	7, N, 2	8, N, 1	
		7, E, 2	8, E, 1	8, N, 2	
	RTU	8, E, 1	8, O, 1	8, N, 1	8, N, 2
Baud rates	1,200bps; 2,400bps; 4,800bps; 9,600bps; 19,200bps; 38,400bps; 57,600bps; 115,200bps				

#### ■ Electrical specification

Power supply	24 VDC (-15% ~ 20%) (with DC input polarity reverse protection)
--------------	---

#### ■ Environment

Noise immunity	ESD (IEC 61131-2, IEC 61000-4-2): 8KV Air Discharge , 4KV Contact Discharge EFT (IEC 61131-2, IEC 61000-4-4): Power Line: 2KV, Digital I/O: 1KV Analog & Communication I/O: 1KV Damped-Oscillatory Wave: Power Line: 1KV, Digital I/O: 1KV RS (IEC 61131-2, IEC 61000-4-3): 80MHz~1000MHz , 1.4GHz~2.0GHz , 10V/m
Operation	0°C ~ 55°C (temperature); 50 ~ 95% (humidity); pollution degree 2
Storage	-25°C ~ 70°C (temperature); 5 ~ 95% (humidity)
Vibration/shock resistance	Standard: IEC 61131-2 · IEC 68-2-6 (TEST Fc)/IEC 61131-2 & IEC 68-2-27 (TEST Ea)
Certificates	IEC 61131-2, UL508

## 2 Product Profile & Outline

### 2.1 Dimension

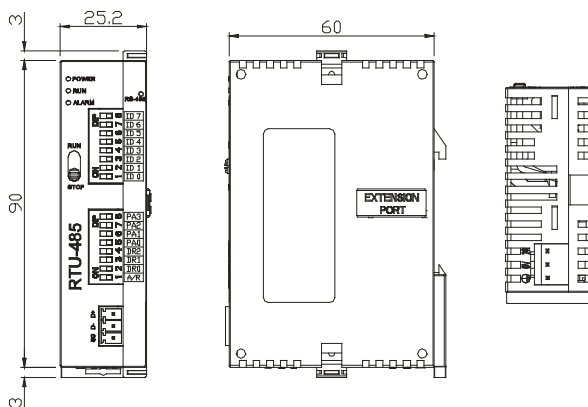

### 2.2 Product Profiles

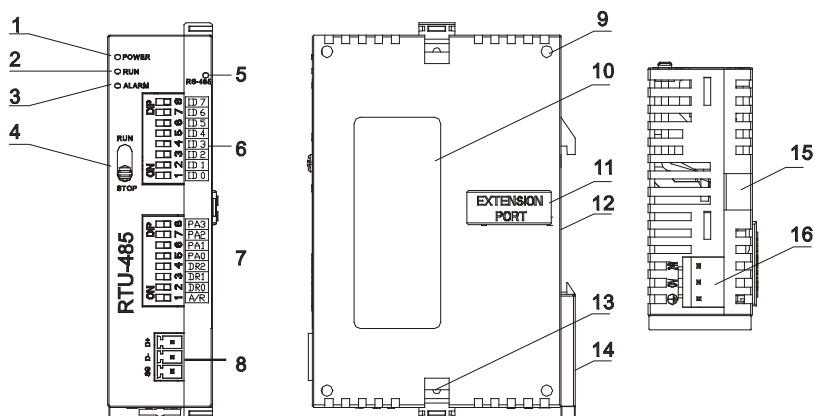

1. POWER indicator	9. Mounting hole for I/O module
2. RUN indicator	10. Nameplate
3. ALARM indicator	11. I/O module connection port
4. RUN/STOP switch	12. DIN rail (35mm)
5. Communication indicator	13. Fastening hole for I/O module
6. Address switch	14. DIN rail clip
7. Communication mode switch	15. Mounting rail for I/O module
8. RS-485 communication port	16. Power input

### 2.3 RUN/STOP Switch

RUN/STOP action	Explanation
RUN	I/O module in RUN mode
RUN → STOP	1. I/O module switches from RUN to STOP. 2. Output points on digital I/O module all turn Off.
STOP	1. Special I/O module in STOP mode 2. Special I/O module cannot be controlled by communication. 3. Digital I/O module cannot be controlled by communication.
STOP → RUN	1. Special I/O module switches from STOP to RUN. 2. RTU-485 redetects the number of points in Slim DI/DO and the number of special I/O modules.

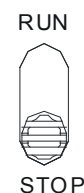

## 2.4 Address Switch

The switch is used on setting up the communication address of RTU-485. Range: H'01 ~ H'F0 (decimal: 1 ~ 240)

Switch setting	Content
H'01 ~ H'F0	Valid communication address ID0 ~ ID7 are defined as: 2 <sup>0</sup> , 2 <sup>1</sup> , 2 <sup>2</sup> , ...2 <sup>6</sup> , 2 <sup>7</sup>
H'00, H'F1 ~ H'FF	Invalid communication address

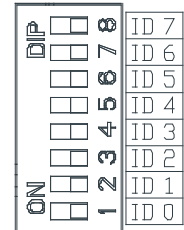

**Example:** If you need to set the address of RTU-485 to 26, switch the DIP switch corresponding to ID4 to “ON”, switch corresponding to ID3 to “ON” and switch corresponding to ID1 to “ON”.

**Note:**

- Please set up the address when the power of RTU-485 is switched off. After the setup is completed, re-power RTU-485.
- When RTU-485 is operating, changing the setting of communication address will be invalid.
- Use slotted screwdriver to adjust the switch carefully in case you scratch the switch.

## 2.5 Communication Mode Switch

These switches are for:

- Setting up communication format (PA0 ~ PA3, A/R)
- Setting up baud rate (DR0 ~ DR2)

PA3	PA2	PA1	PA0	A/R	Format
OFF	OFF	OFF	OFF	ON	7,E,1, ASCII
OFF	OFF	OFF	ON	ON	7,O,1, ASCII
OFF	OFF	ON	OFF	ON	7,E,2, ASCII
OFF	OFF	ON	ON	ON	7,O,2, ASCII
OFF	ON	OFF	OFF	ON	7,N,2, ASCII
OFF	ON	OFF	ON	ON	8,E,1, ASCII
OFF	ON	ON	OFF	ON	8,O,1, ASCII
OFF	ON	ON	ON	ON	8,N,1, ASCII
ON	OFF	OFF	OFF	ON	8,N,2, ASCII
OFF	ON	OFF	ON	OFF	8,E,1, RTU
OFF	ON	ON	OFF	OFF	8,O,1, RTU
OFF	ON	ON	ON	OFF	8,N,1, RTU
ON	OFF	OFF	OFF	OFF	8,N,2, RTU

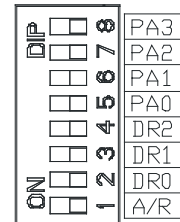

DR2	DR1	DR0	Baud rate (bps)
OFF	OFF	OFF	1,200
OFF	OFF	ON	2,400
OFF	ON	OFF	4,800
OFF	ON	ON	9,600
ON	OFF	OFF	19,200
ON	OFF	ON	38,400
ON	ON	OFF	57,600
ON	ON	ON	115,200

**Note:**

- Please set up the switch when the power is switched off. After the setup is completed, re-power RTU-485.
- When RTU-485 is operating, changing the setting of the switch will be invalid.
- Use slotted screwdriver to adjust the switch carefully in case you scratch the switch.

## 3 Basic Operation

### 3.1 Connecting RTU-485 to DVP Slim DI/DO Extension Unit

- Open the fixing clips on top and bottom of RTU-485. Meet the extension port of Slim DI/DO with RTU-485.
- Press the fixing clips on top and bottom of Slim DIDO and check if the connection is fine.

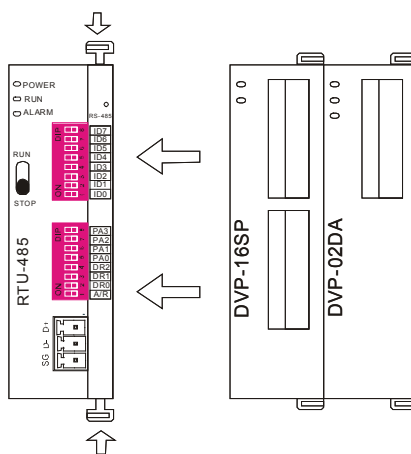

### 3.2 Installing RTU-485 and DVP Slim DI/DO on DIN Rail

- Use 35mm DIN rail.
- Open the DIN rail clip on RTU-485 and Slim DI/DO. Insert RTU-485 and Slim DI/DO onto the DIN rail.
- Clip up the DIN rail clips on RTU-485 and Slim DI/DO to fix them on the DIN rail, as shown below.

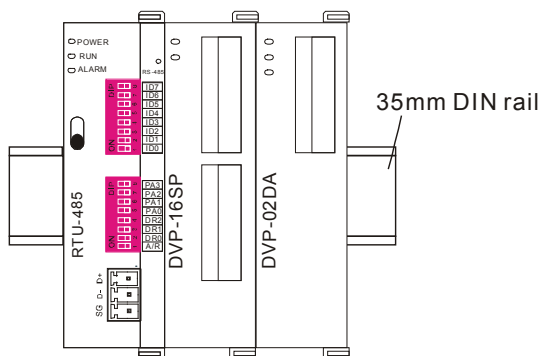

## 4 Areas for Special Functions

### 4.1 Areas in Digital I/O Module

Communication address	Devices	Attribute	Data type	Length
H'0400 ~ H'047F	X: X000 ~ X177 (Octal)	R	bit	128 points
H'0500 ~ H'057F	Y: Y000 ~ Y177 (Octal)	R/W	bit	128 points



## 4.2 Areas in Special I/O Module

Communication address	Devices	Attribute	Data type	Length
H'1600 ~ H'1630	1 <sup>st</sup> special I/O module: CR0 ~ CR48	Please refer to the CR attribute of each special I/O module.	word	49
H'1640 ~ H'1670	2 <sup>nd</sup> special I/O module: CR0 ~ CR48		word	49
H'1680 ~ H'16B0	3 <sup>rd</sup> special I/O module: CR0 ~ CR48		word	49
H'16C0 ~ H'16F0	4 <sup>th</sup> special I/O module: CR0 ~ CR48		word	49
H'1700 ~ H'1730	5 <sup>th</sup> special I/O module: CR0 ~ CR48		word	49
H'1740 ~ H'1770	6 <sup>th</sup> special I/O module: CR0 ~ CR48		word	49
H'1780 ~ H'17B0	7 <sup>th</sup> special I/O module: CR0 ~ CR48		word	49
H'17C0 ~ H'17F0	8 <sup>th</sup> special I/O module: CR0 ~ CR48		word	49

Note: Maximum 8 special I/O modules are connectible to RTU-485. The first special module connected is the nearest one on the right hand side of RTU-485, and so on.

## 4.3 Special Functions

Communication address	Attribute	Content	Explanation
H'0000	R	Model name	Set up by the system. Model code of RTU-485 = H'0200.
H'0001	R	Firmware version	The current firmware version is displayed in hex, e.g. V0.1 is indicated as H'0010.
H'0002	R	Issue date	The issue data of the firmware is displayed in hex, e.g. H'1FD0 = K8150 indicates that the firmware is issued on the morning of August 15.
H'0003	R/W	RUN/STOP RTU-485	H'0003 = K1, RTU-485 RUN; H'0003 = K0, RTU-485 STOP.
H'0004	R	Communication format	Displaying the communication format of RTU-485.
H'0005	R	Baud rate	Displaying the baud rate of RTU-485.
H'0006	R	Communication address	Displaying the communication address of RTU-485.
H'0007	R	Number of DI/DO points	High byte stores the number of input points. Low byte stores the number of output points.
H'0008	R	Error code	Recording the current error. See 17.4.4 for the meaning of error codes.
H'0009	R	Historical error code	The number of errors occurring. Range: 0 ~ 32
H'0017	R	Number of special I/O modules	The number of special I/O modules RTU-485 detects.
H'0018	R	Model code of the 1 <sup>st</sup> special I/O module	The model code of the 1 <sup>st</sup> special I/O module connected to RTU-485.
H'0019	R	Model code of the 2 <sup>nd</sup> special I/O module	The model code of the 2 <sup>nd</sup> special I/O module connected to RTU-485.
H'001A	R	Model code of the 3 <sup>rd</sup> special I/O module	The model code of the 3 <sup>rd</sup> special I/O module connected to RTU-485.
H'001B	R	Model code of the 4 <sup>th</sup> special I/O module	The model code of the 4 <sup>th</sup> special I/O module connected to RTU-485.

Communication address	Attribute	Content	Explanation
H'001C	R	Model code of the 5 <sup>th</sup> special I/O module	The model code of the 5 <sup>th</sup> special I/O module connected to RTU-485.
H'001D	R	Model code of the 6 <sup>th</sup> special I/O module	The model code of the 6 <sup>th</sup> special I/O module connected to RTU-485.
H'001E	R	Model code of the 7 <sup>th</sup> special I/O module	The model code of the 7 <sup>th</sup> special I/O module connected to RTU-485.
H'001F	R	Model code of the 8 <sup>th</sup> special I/O module	The model code of the 8 <sup>th</sup> special I/O module connected to RTU-485.

## 4.4 Error Codes

Code	Indication	Explanation
0001	Incorrect function code	RTU-485 does not support this function code.
0002	Incorrect operand address	The address of a certain device is not within the range, or the data written into it are incorrect.
0003	Incorrect data	The data read/written exceed the maximum length.
0004	RTU-485 STOP	RTU-485 in STOP mode.
000B	Incorrect communication format	The length of data received by RTU-485 is too short.
000C	Incorrect communication format	The length of data received by RTU-485 is too long.

## 5 Function Codes RTU-485 Supports

RTU-485 complies with the standard Modbus protocol, supporting 7 function codes, which are H'01, H'02, H'03, H'05, H'06, H'0F and H'10. Please refer to the standard Modbus protocol for the specific data format of each function code.

Code	Function	Data type	Applicable address
H'01	Reading the output status of bit device.	bit	DO area: H'0500 ~ H'057F
H'02	Reading the input status of bit device	bit	DI area: H'0400 ~ H'047F
H'03	Reading register	word	Area for special functions: H'0000 ~ H'001F
			CR for the 1 <sup>st</sup> special I/O module: H'1600 ~ H'1630
			CR for the 2 <sup>nd</sup> special I/O module: H'1640 ~ H'1670
			CR for the 3 <sup>rd</sup> special I/O module: H'1680 ~ H'16B0
			CR for the 4 <sup>th</sup> special I/O module: H'16C0 ~ H'16F0
			CR for the 5 <sup>th</sup> special I/O module: H'1700 ~ H'1730
			CR for the 6 <sup>th</sup> special I/O module: H'1740 ~ H'1670
			CR for the 7 <sup>th</sup> special I/O module: H'1780 ~ H'16B0
CR for the 8 <sup>th</sup> special I/O module: H'17C0 ~ H'17F0			
H'05	Writing single datum into bit device	bit	DO area: H'0500 ~ H'057F
H'06	Writing single datum into register	word	RTU-485 RUN/STOP mode: H'0003
			Applicable to CR with R/W attribute in the 1 <sup>st</sup> ~ 8 <sup>th</sup> special I/O module
H'0F	Writing multiple data into bit device	bit	DO area: H'0500 ~ H'057F
H'10	Writing multiple data into register	word	Applicable to CR with R/W attribute in the 1 <sup>st</sup> ~ 8 <sup>th</sup> special I/O module

## 6 Application of RTU-485

### 6.1 Connection between RTU-485 and Master Device

As a standard Modbus slave, RTU-485 is compatible with other programmable logic controllers which also comply with Modbus protocol. The example here takes DVP-SV PLC as the master. The PC downloads the ladder diagram program to DVP-SV through RS-232 communication port (COM1). When DVP-SV executes the ladder diagram program, it will send out Modbus command through RS-485 communication port (COM2) and conduct remote I/O control on RTU-485. See the figure on the next page for the connection between RTU-485 and the master device:

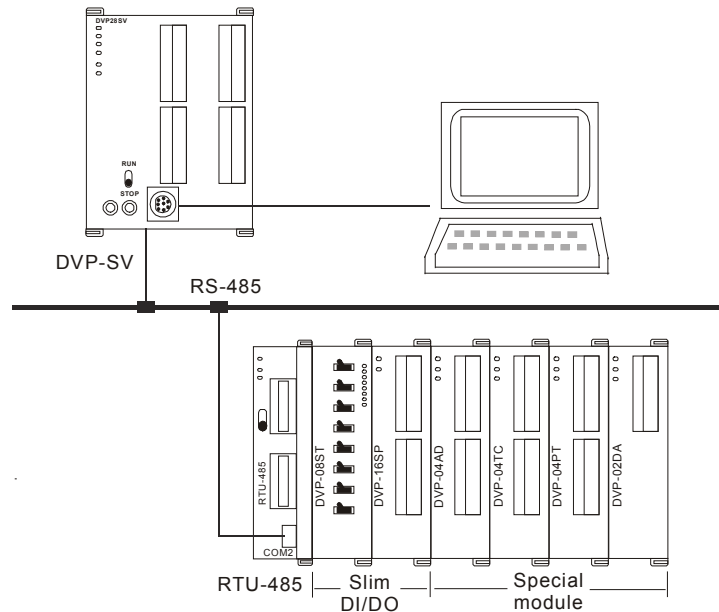

### 6.2 Application Example

#### ■ Example 1

- ◆ The station No. of RTU-485 is "1". Write "H'0001" into CR#6 of the 1<sup>st</sup> special I/O module.

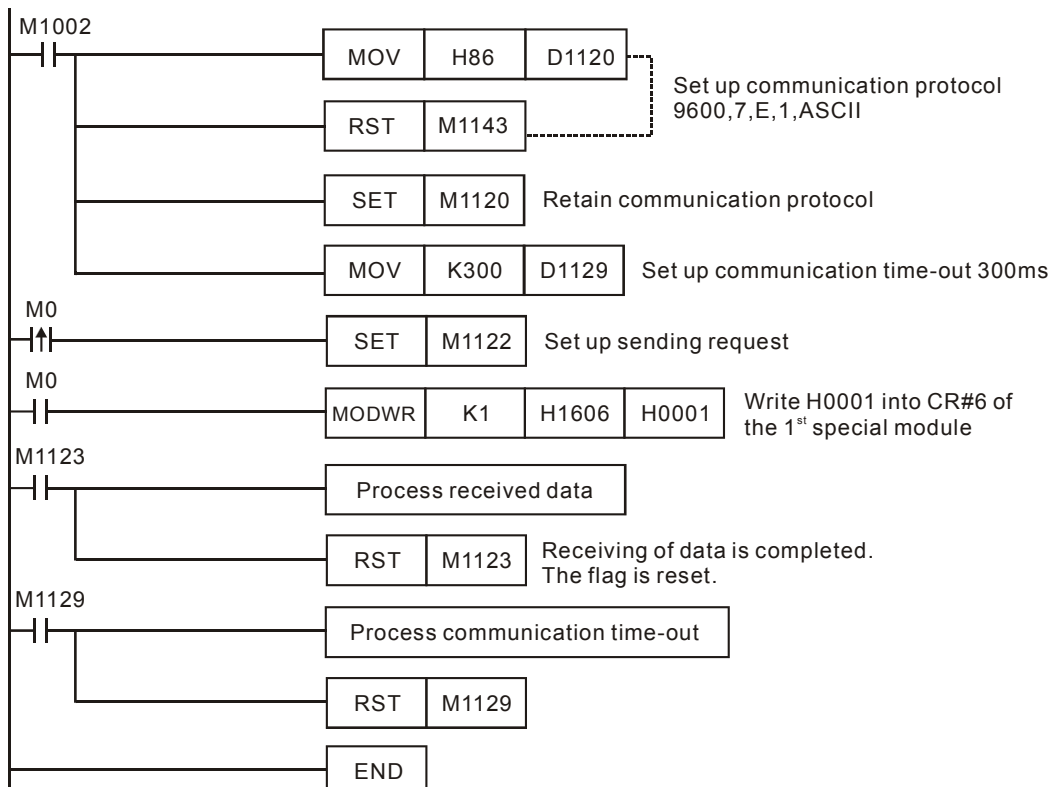

◆ Explanations

1. You have to set up the communication format at the beginning of the program. The communication format for the master and slave has to be consistent, e.g. you can see the format is 9600, 7, E, 1, ASCII from this example.
2. After setting up the communication format, you have to set up the communication retention device M1120 of COM2.
3. After M0 is On, set up the sending request flag, and the master device will send out a request message to RTU-485 and write H'0001 into CR#6 of the 1<sup>st</sup> special module on the right hand side of RTU-485.

■ Example 2

- ◆ The station No. of RTU-485 is "1". Set up Y0 of the Slim DI/DO on the right hand side of RTU-485.

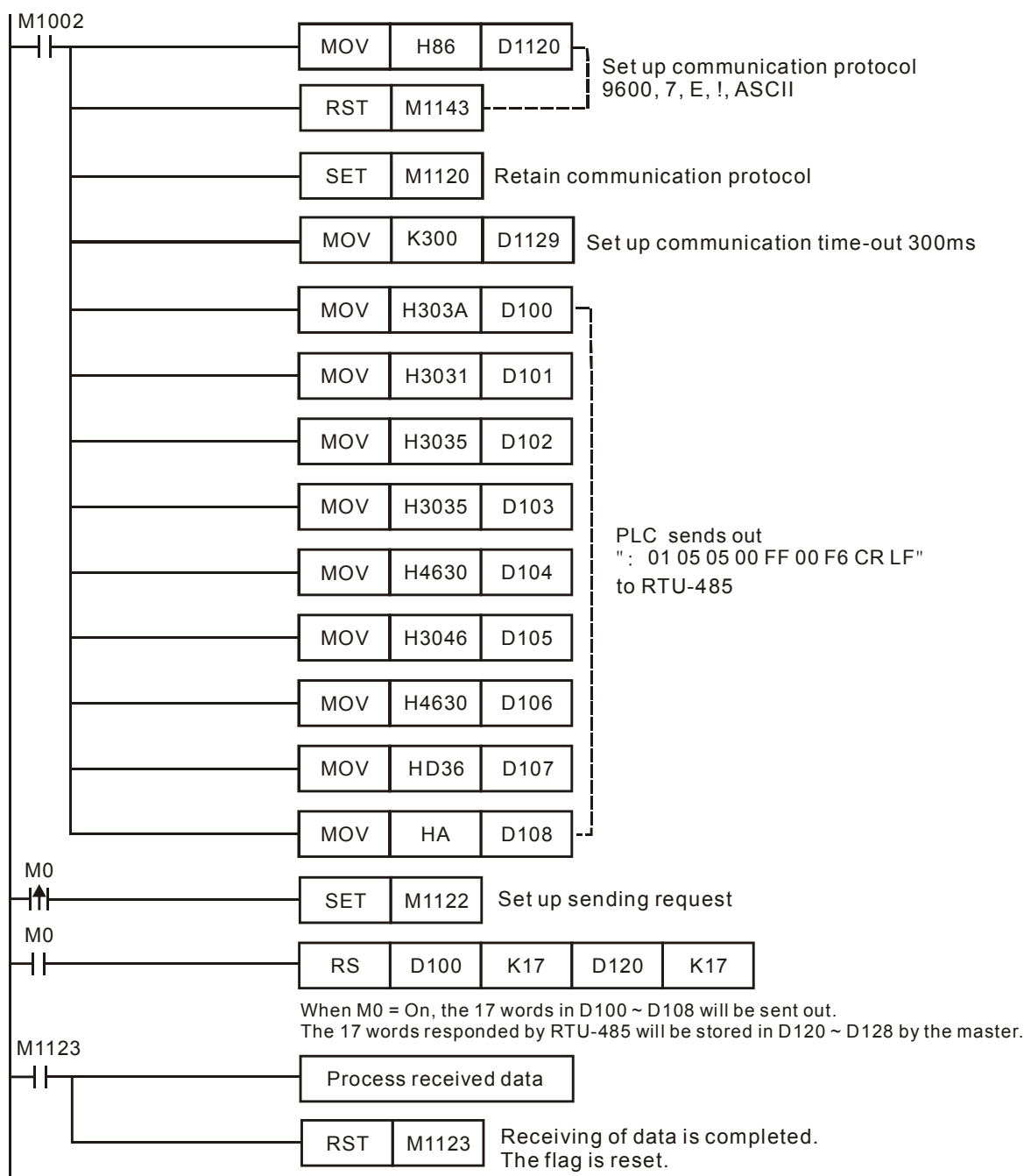

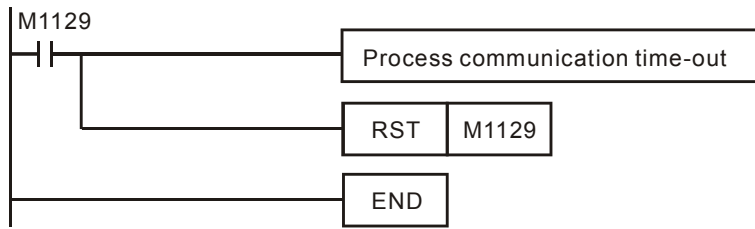

◆ Explanations

1. You have to set up the communication format at the beginning of the program. The communication format for the master and slave has to be consistent, e.g. you can see the format is 9600, 7, E, 1, ASCII from this example.
2. The master PLC sends out data to RTU-485 in ASCII, e.g. the high byte “30” in D100 refers to “0” and low bytes “3A” refers to the head code “:”.
3. After M0 is On, set up M1122. At this moment, the master PLC will send the 17 words of data in D100 ~ D108 to RTU-485 by RS instruction. The data in low words will be sent first. The master PLC will store the responding message sent by RTU-485 into D120 ~ D128.

## 7 LED Indicator & Trouble-shooting

There are four LED indicators on RTU-485, which are POWER, RUN, ALARM and RS-485, for displaying the working status and communication connection status of RTU-485.

### 7.1 POWER LED

LED status	Indication	How to correct
Off	No power or the power is abnormal.	Check the power of RTU-485 and see if the connection is normal.
Green light On	The power of RTU-485 is normal.	--

### 7.2 RUN LED

LED status	Indication	How to correct
Off	RTU-485 is in STOP status.	--
Green light On	RTU-485 is in RUN status.	--

### 7.3 ALARM LED

LED status	Indication	How to correct
Off	The power is in low voltage.	Check if the power of RTU-485 is normal.
Red light On	Incorrect communication format for RTU-485	Check if the communication format for RTU-485 is correct.
	Incorrect communication address for RTU-485	Check if the communication address of RTU-485 is valid.
	RTU-485 is not connected to I/O module.	Check if RTU-485 is connected to extension module normally.
	More than 8 special I/O modules connected to RTU-485.	Check and make sure that the number of special I/O modules connected to RTU-485 is less than 8.
	The number of points on digital I/O module connected to RTU-485 exceeds the range.	Check and make sure the number of input points on digital I/O module connected to RTU-485 is less than 128, and output points also less than 128.

## 7.4 RS-485 LED

LED status	Indication	How to correct
Off	RTU-485 is not communicating with the master device.	--
Red light flashing	RTU-485 is communicating to the master device normally.	--